

willowcreek
deer

'Genetics from New Zealand's finest'



**Elite
Stag and Yearling
Sale**

10am, 7 January 2014

Insignis Park, Christchurch



Conditions of Sale

AGENTS

Harry and Carol Waghorn (03) 312 9856, Fax (03) 312 9850

Matt Waghorn 027 341 1280

Agents for PGG Wrightson

North Island

Keith Burden (Hawkes Bay) 027 597 5801

Cam Heggie (Waikato) 027 501 8182

South Island

Ron Schroeder (Nth Cant, Marlborough/West Coast) 027 432 1299

Brian Newall (South Canterbury) 027 595 6448

John Williams (Otago) 027 241 4179

Graeme Kinsman (Deer Stud Coordinator) 027 422 3154

Brian Duggan (Southland) 027 432 4217

Auctioneer

John Duffy (Central Otago) 027 240 3841

Neville Clark 027 598 6537

Independent Agents

Bob Dunn 027 494 8716

Peter Crowle 027 490 5786

Rural Lifestock

Adam Whaanga 0274 183 438

Willowcreek Deer

Harry & Carol Waghorn

Lower Sefton Road, RD 7, Rangiora, New Zealand

Phone: +64 3 312 9856 Fax: +64 3 312 9850

Email: willowcreekdeer@clear.net.nz

1. The sale will be conducted by PGG Wrightson with the conditions of the sale as set down by the New Zealand Stock and Stations Agents Association, a copy of which is exhibited in the office on sale day.
2. Each lot becomes the purchase's property and risk at the fall of the hammer.
3. Warranties and insurance are covered under separate headings.
4. Terms are strictly cash unless prior arrangements are made with the auctioneers. Accounts not paid within 14 days of sale shall bear interest, at current rate per annum from the date of sale.
5. The sale is conducted exclusive of GST.
6. A buyers commission of 4% is payable to non-participating companies and recognised independent agents introducing and accompanying purchases to the sale providing prior arrangements [no later than 24hrs prior to the sale] are made with PGG Wrightson.
7. Intending purchases are required to register with the auctioneers prior to the commencement of the sale.
8. TB Status clear C10.
9. All animals Johnes tested clear.
10. No animals, embryos or semen sold by Willowcreek Deer or their germplasm any subsequent progeny or germplasm, including the semen and germplasm of the progeny may be supplied to any third party without written permission of Willowcreek Deer. This condition does not affect normal commercial deer farming or stud farming on their normal sales of semen or embryos as it only applies to entities with the primary function of commercial semen, germplasm activity.

DISCLAIMER

All details and description as to stock referred to in this catalogue have been supplied to PGG Wrightson by the vendor and have not been independently verified by PGG Wrightson. PGG Wrightson, its employees and agents make no representations or warranties or acknowledgement of any kind whatsoever in relation to any part of this catalogue [including but not limited to accuracy or completeness of details and description of stock {and other contents}]. Purchases, advisors and all other persons viewing or dealing with the stock must make their own assessment of the stock and the information in this catalogue. PGG Wrightson, its employees and agents are not responsible or liable in any way whatsoever, whether in contract, tort [including negligence], or otherwise, to any person for any loss or any damage whatsoever arising directly or indirectly from any information or misrepresentation included or omitted from this catalogue.



Age	Year	LIVE Weight	Antler
5	2008	287 Kg	25 pts
6	2009	284 Kg	558 IOA
7	2010	290 Kg	558 IOA
8	2011		602 IOA

Jabuka

602 IOA @ 8yrs

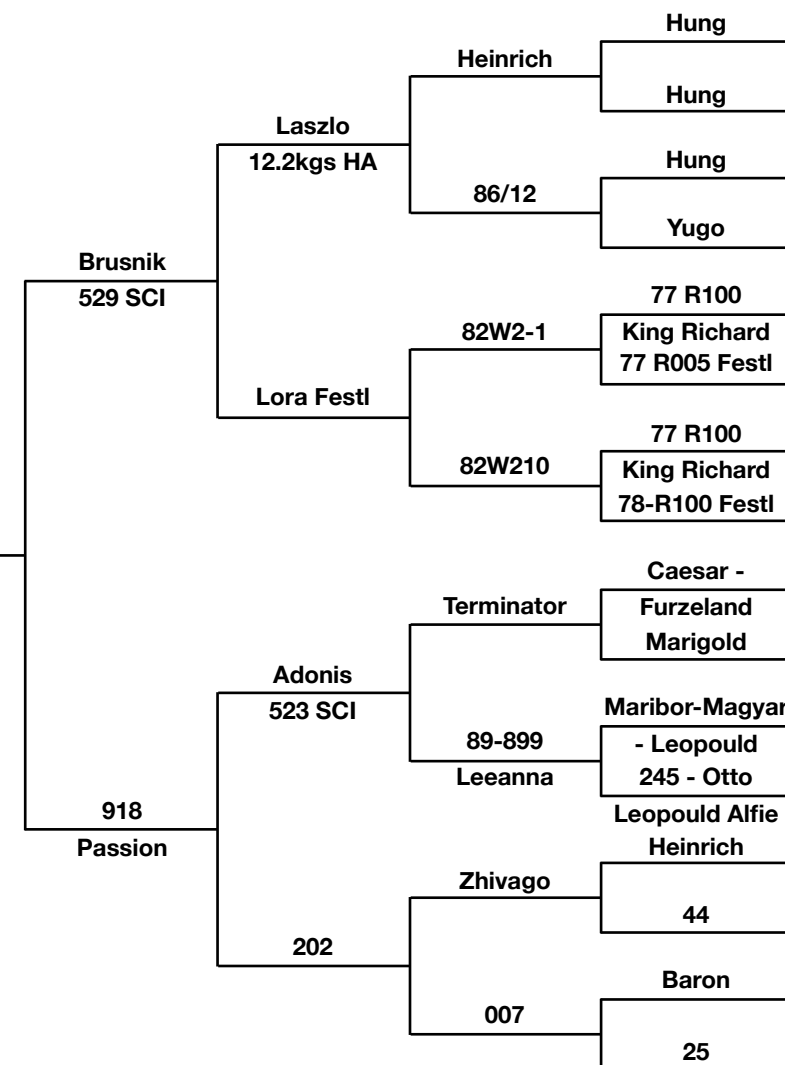

We are proud to have produced a stag of such high calibre here at Willowcreek. Jabuka sports a huge wide, expansive antler with massive royals. Jabuka scored 602 IOA this season and like his full brother Zidarn who scored 653 is a truly magnificent stag. At 8 years Jabuka is an impressive stag and we are proud to offer genetics of this high quality to the Deer Industry.

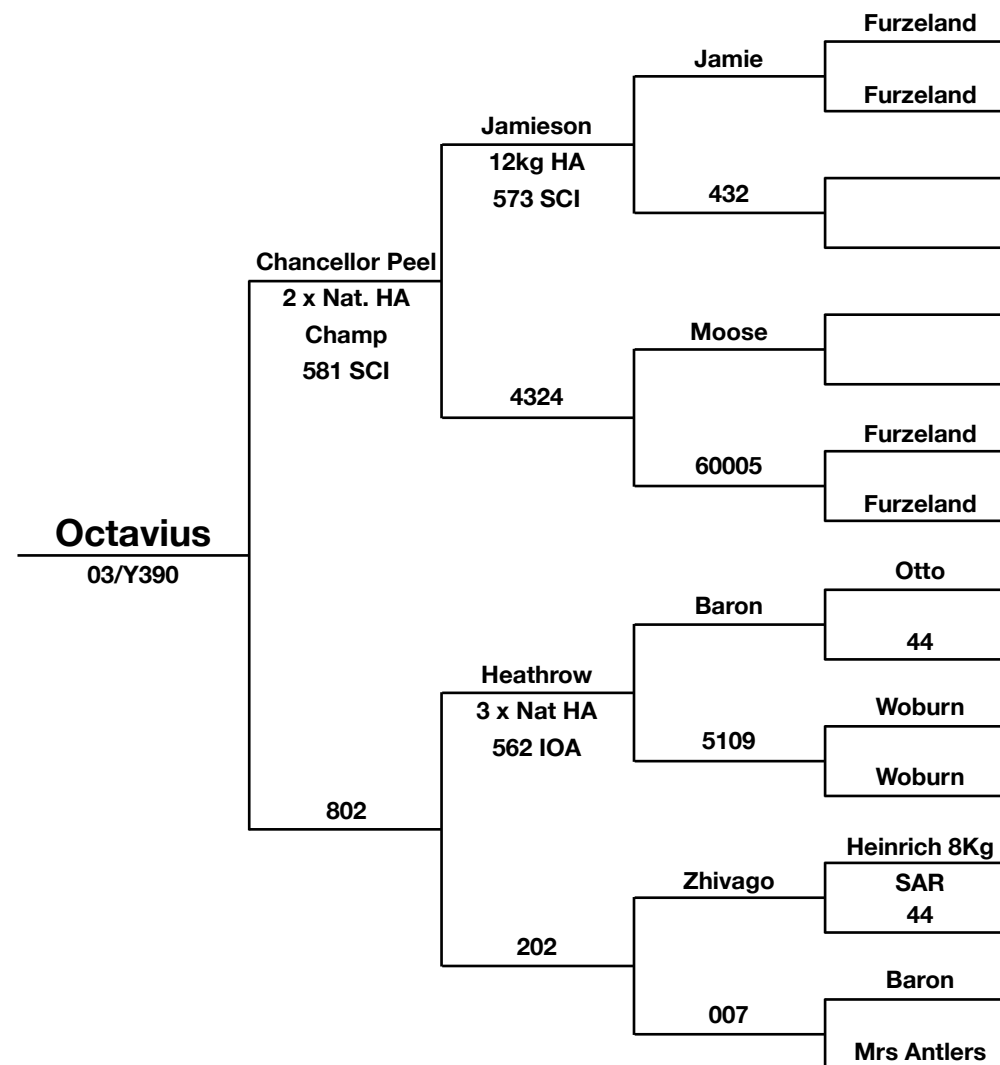

Age	Year	LIVE Weight	Antler
6	2009	290 Kg	460 IOA
7	2010	302 Kg	464 IOA
8	2011	294 Kg	510 SCI

An outstanding son of Chancellor Peel. Octavius has a tremendous temperament and is a sire with something special to offer. Octavius has long powerful lower tynes, leading into multi points which are well suited for the Trophy market. With 36 points and a fantastic body weight, Octavius is a stag who is fast enhancing our stud deer herd.

Sire Reference - PTOLEMY

At 5 YRS



Age	Year	LIVE Weight	Antler
3	2010	-	n/a
4	2011	-	n/a
5	2012	-	505 IOA

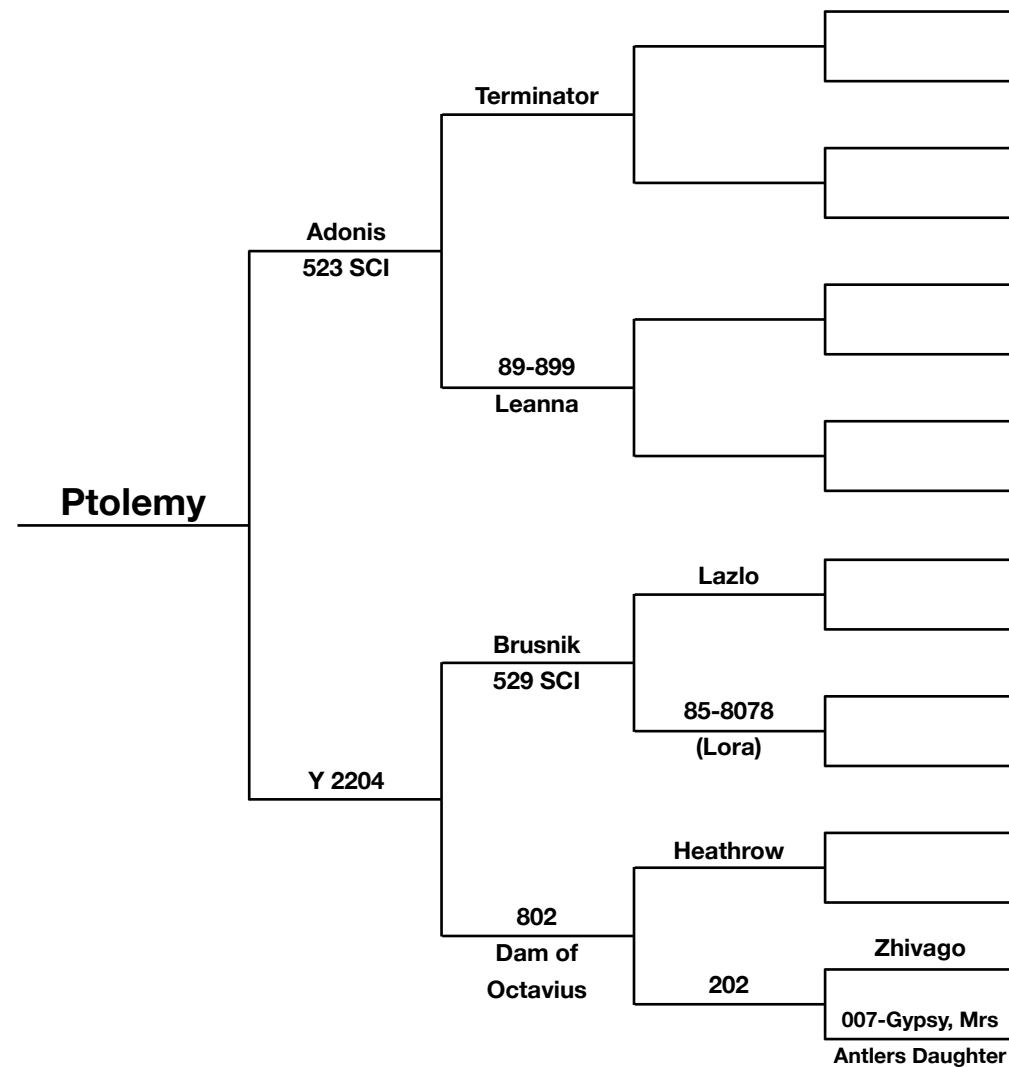

Ptolemy is jointly owned with Andrew and Fiona Fishburn. An outstanding son of Adonis with an extremely wide attractive, eye catching set of antlers, correct tyne placement and clean open tops. We are already seeing his progeny with exceptional Spikers and 2 year olds.

Sire Reference - ARCHIMEDES

At 6 YRS



Age	Year	LIVE Weight	Antler
3	2010	256 Kg	430 IOA
4	2011	297 Kg	465 IOA
5	2012	305 Kg	507 IOA 16.3 HA

Archimedes

507 IOA @ 5 yrs

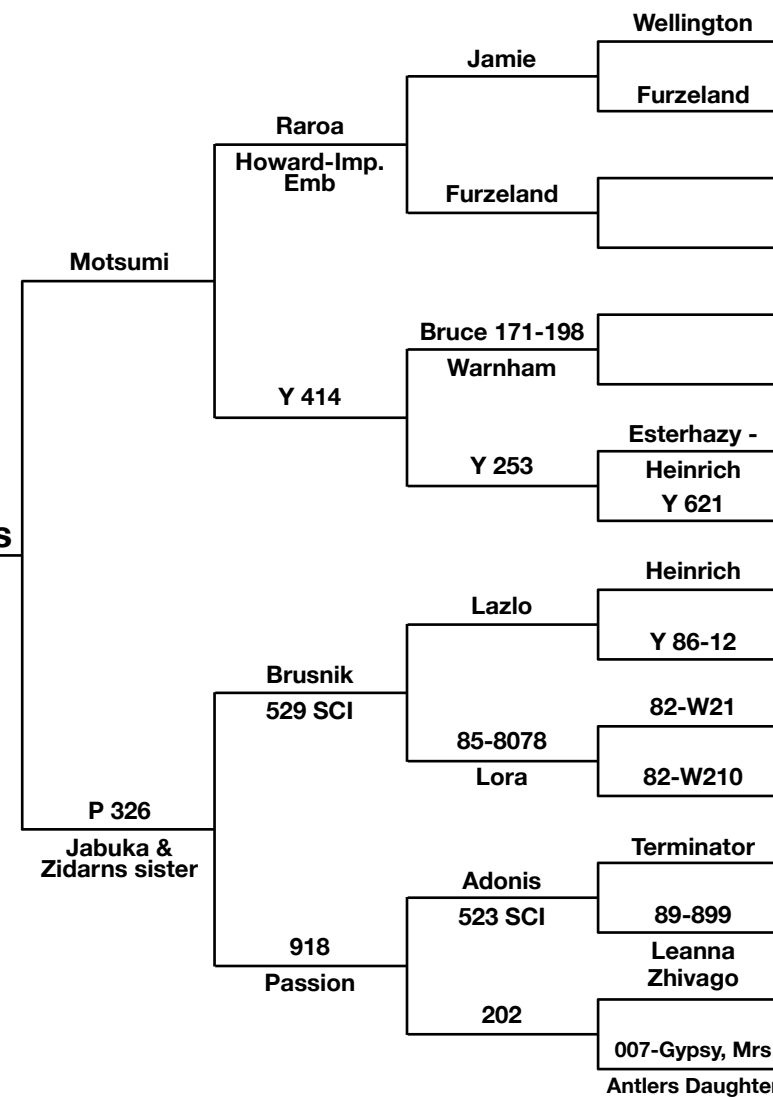

Archmedes is an exciting Sire here at Willowcreek Deer. At 5 years of age Archmedes has an outstanding set of antlers, with thick beam and nice long tynes leading into massive royals. His background only enhances the heritability of these fine genetics with Motsumi, Brusnik and Adonis, a former world champion all featuring. We are excited to offer top genetics such as these. Last year Archmedes scored 507 IOA at 5 years and we look forward to watching his progeny excel.

Sire Reference - KAVOS

AT 6 YRS



Like Jabuka we are proud to have produced a stag of such high calibre and Trophy potential. Kavos scored 489 and carries a head of similar style to his father Jamieson, one of long clean brow bey and trez leading into multipointed royals. This style of head is very sought after by Trophy buyers, and with the pedigree behind Kavos, we look forward to watching this young sire exceed expectations here at Willowcreek Deer.

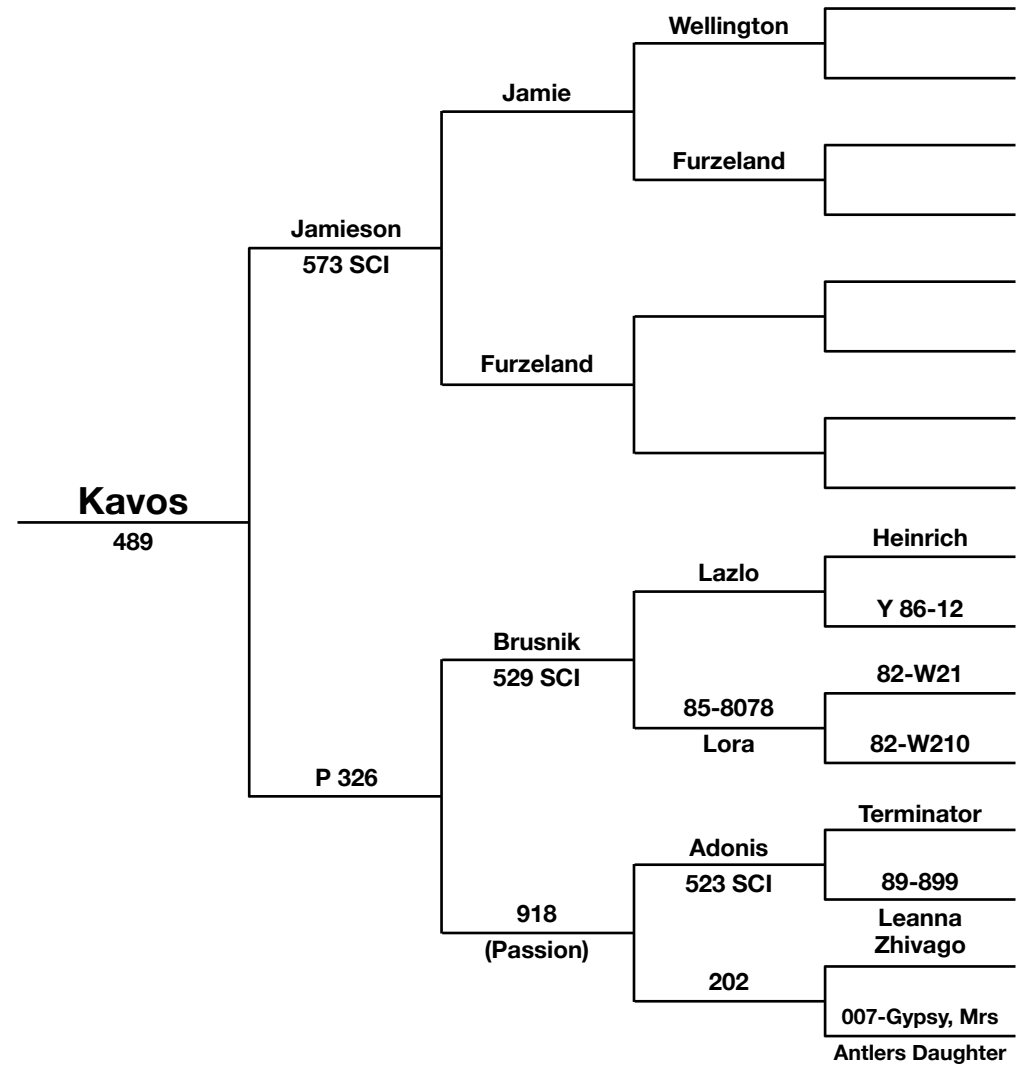



One of the most outstanding sires the New Zealand Deer industry has ever seen. With his massive spread, and unbelievable royals, Brusnik has made an ever lasting impression. His heritable trait is something to be desired. All around the country sons of Brusnik are scoring well into the 600 SCI. Without a doubt, Brusnik is known to those in the industry as one of the finest stags yet.

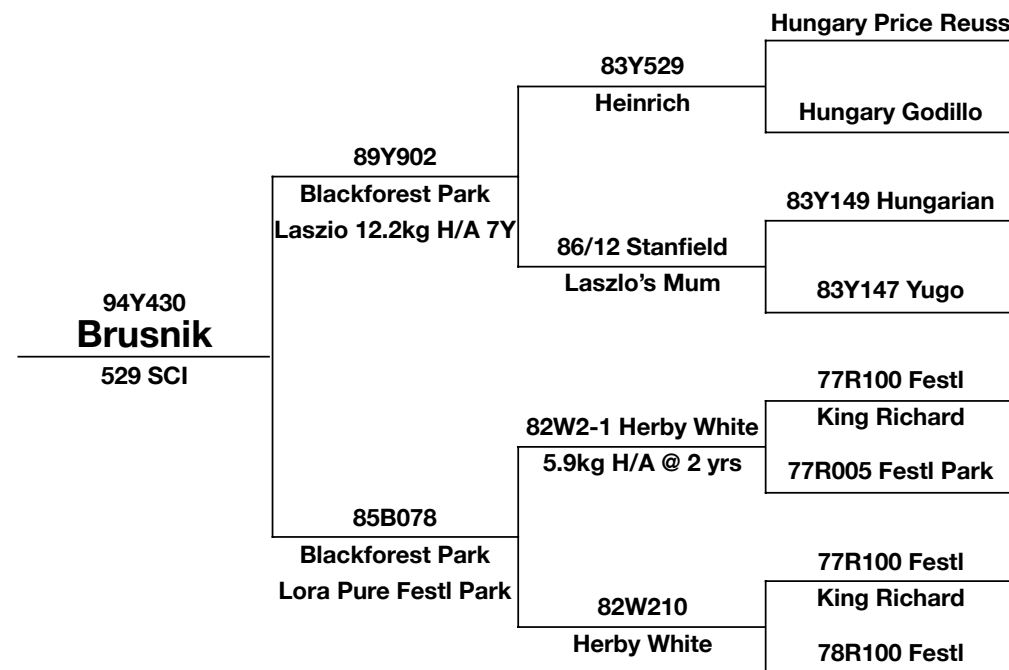

Age	Weight Kgs	Hard Antler Kgs	Points	SCI
2	215	5.09	20	No record
3	Not Recorded	6.09	22	No record
4	Not Recorded	8.40	29	440
5	270	11.50	29	460
6	293	11.60	33	502
7	308	11.60	29	482 7/8
8	321	12.60	31	500 7/8
9	-	13.4	28	516 4/8
10	-	13.2	30	518 6/8
11	Trophyed	Trophyed	Trophyed	529

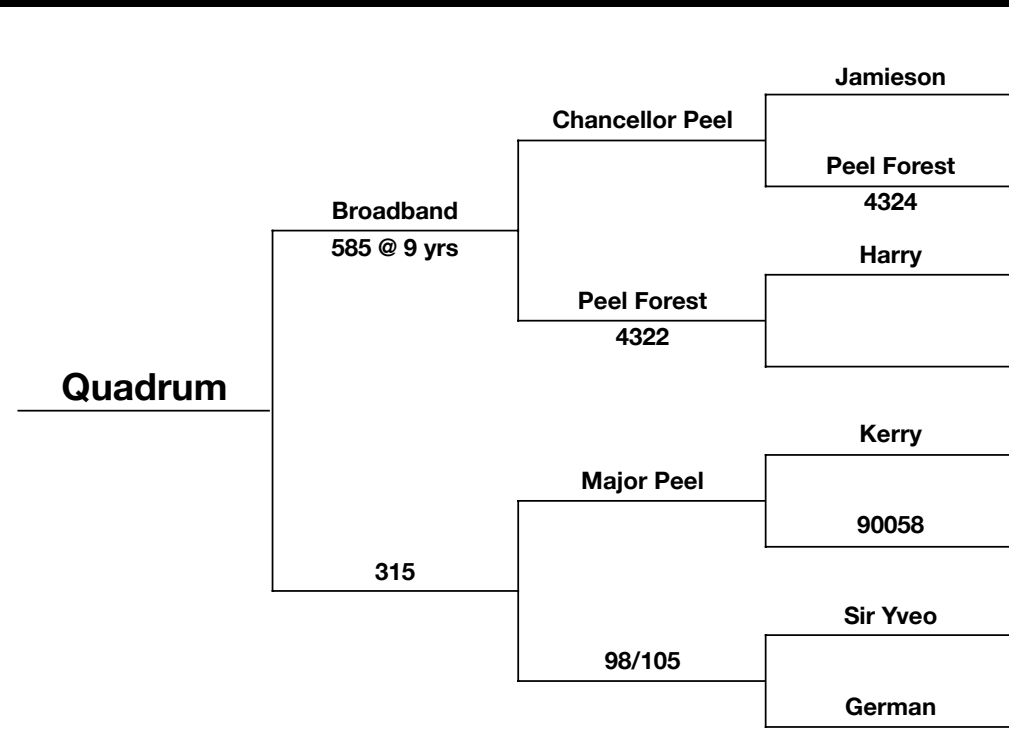

Age	Year	Live Weight	Score
3	2012	221 Kg	440



New Sire Quadrum was purchased from Malcolm Cains 2012 Stag Sale, and we believe he is the best Broadband son that has been bred. As a three year old Quadrum scored 440 IOA and has very eye catching antlers. He is very wide with long tynes leading into massive royals. We look forward to his progress here at Willowcreek.

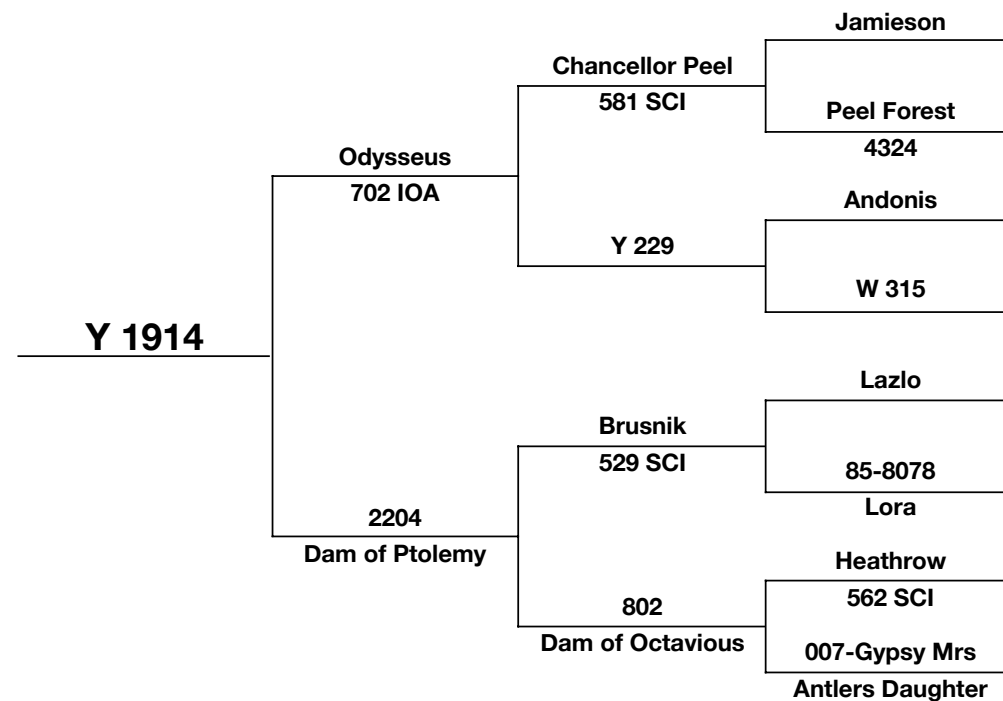

Y 1914 is a half brother to Ptolemy, and with Odysseus as his Sire, and 2204 as his Dam, will grow into a fantastic young stag. Y 1914 was cut for velvet last year and was used for Sire duties because of his potential. This year Y1914 is showing a very long open, clean style Antler.



Y 1005

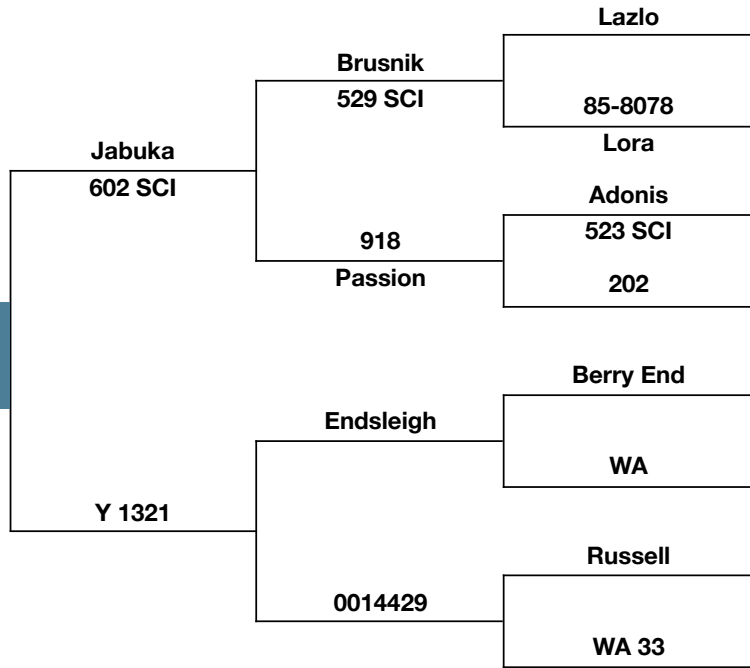

Y 1005 is Y 1321s first stag and with the impressive Jabuka as his sire will get bigger and stronger as he matures. He is showing great potential at this early stage of growth with very long brows and heavy beam.

Purchaser: _____ Price: _____ Weight: _____

Y 1046

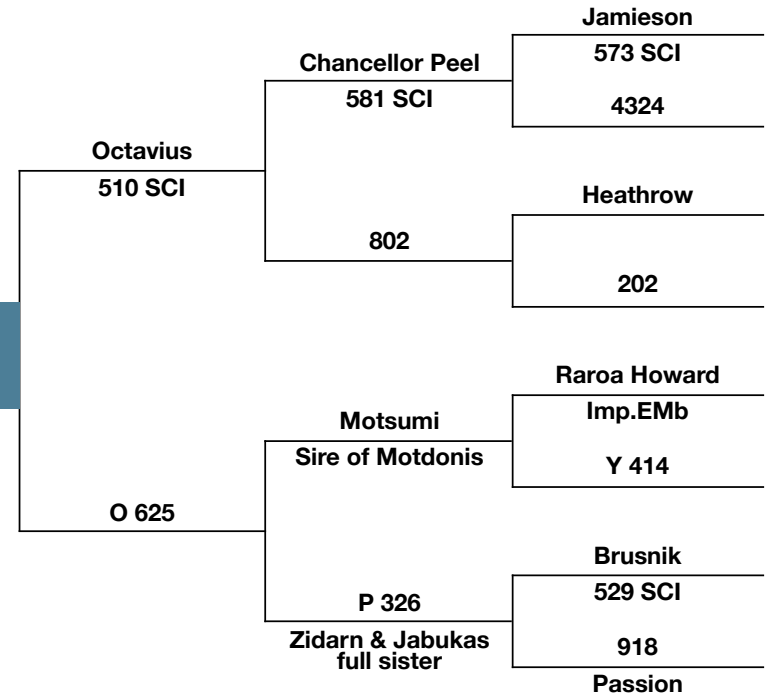

This is a young sire not to be missed with a pedigree such as this. Chancellor Peel, Brusnik and Motsumi are sires of some of the biggest antlered stags produced. Y1046 comes from the greatest Dam line in the industry.

Purchaser: _____ Price: _____ Weight: _____



Y 1009

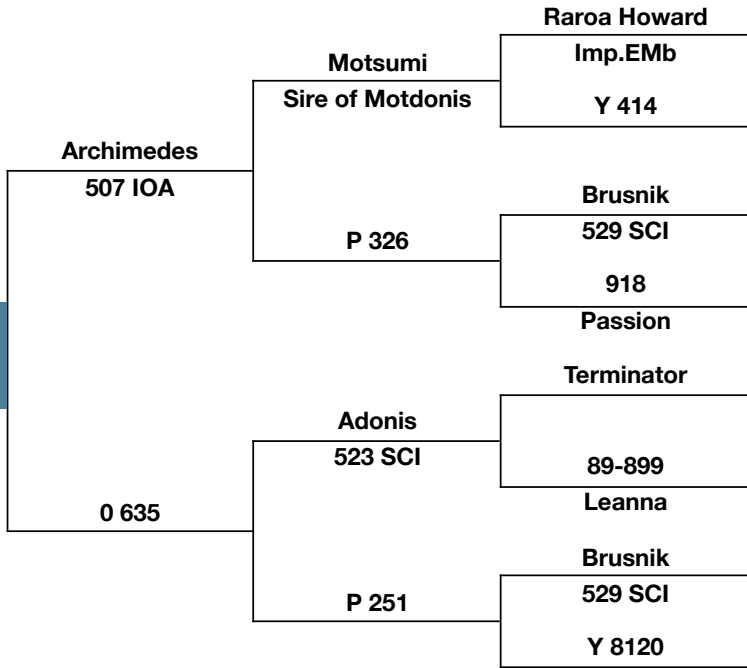

You can expect big things from this stag. With Archimedes over Dam O635 a Adonis daughter who is full sister to lot 9 which sold for \$5000 in 2009 stag sale. Y 1009 is progressing nicely with long, wide antlers leading up to a big bulb.

Purchaser: _____ Price: _____ Weight: _____

Y 1011

Ptolemys half brother

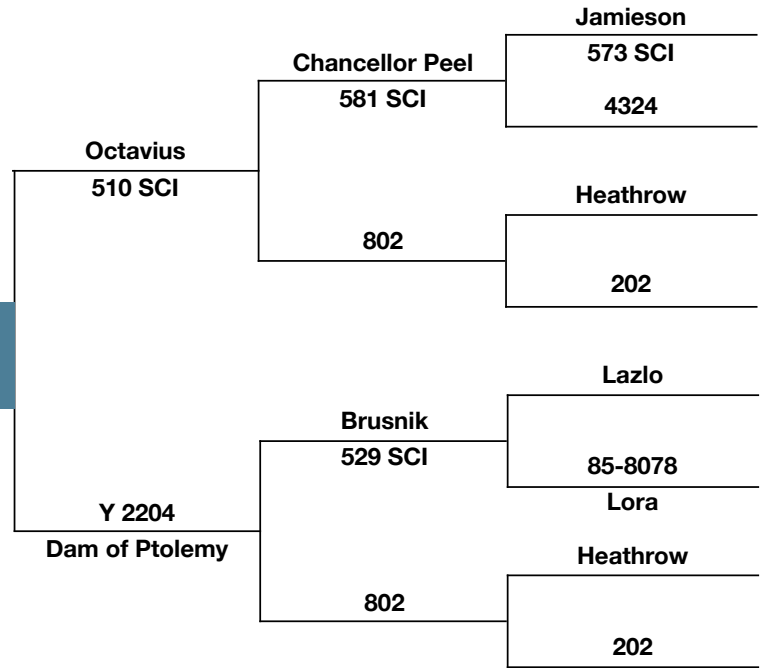

This young sire is not to be missed, Octavius who had a classic style head with big beam, long and correct style antler over our top Dam 2204. 2204 does not stop impressing us and has produced top stags such as Ptolemy, Azlan, and Y1914. This stag although early, is looking good having wide antlers with bifurcating trey tynes.

Purchaser: _____ Price: _____ Weight: _____



Y 1049

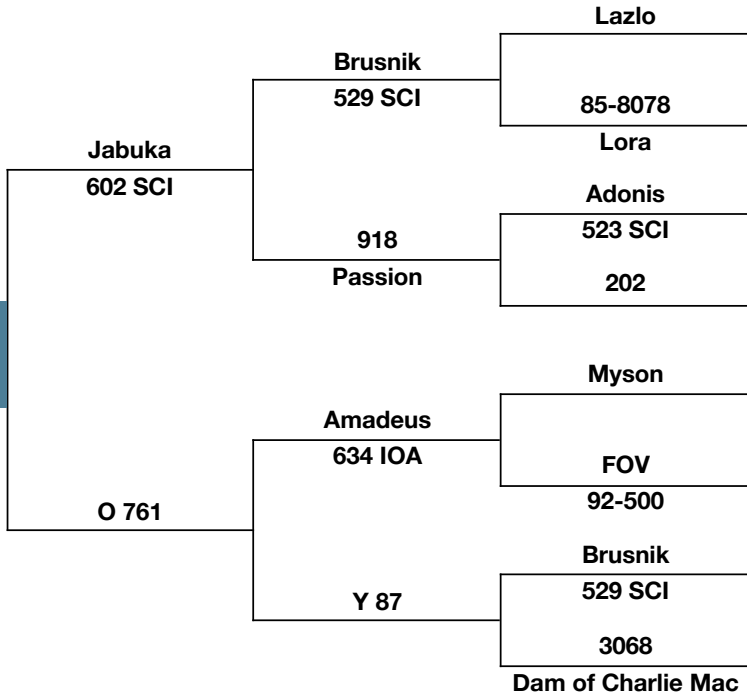

Y 1020

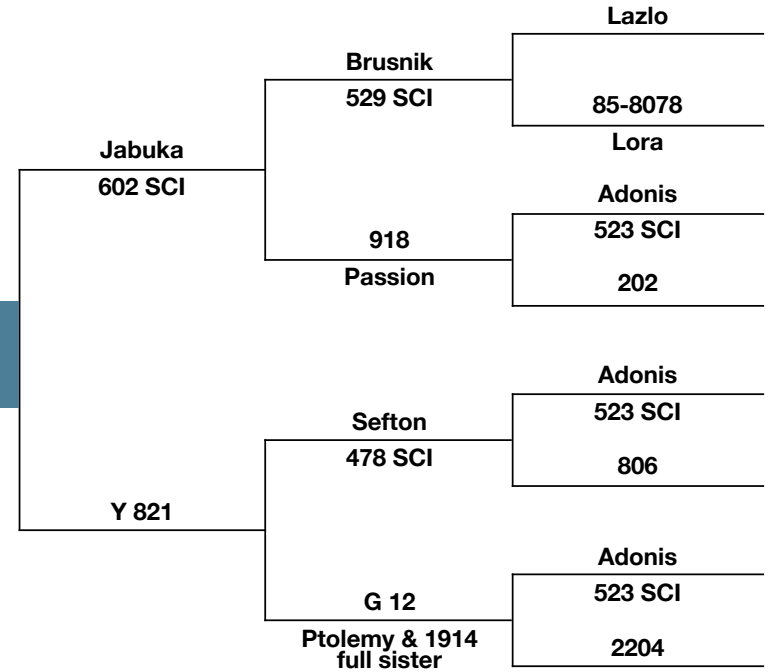

Another great example of New Zealand's finest Genetics. This sire comes from a family of big, long, wide, heavy antler and is not to be over looked he is young and I believe will mature into a fine sire. He has started well and looks to be bulbing up to have good points.

A very attractive long clean antler from Y 1020. With Jabuka 602SCI as his sire and a Dam relating back to Y2204 (ptolemys Dam), I would expect big things from this stag.

Purchaser: _____ Price: _____ Weight: _____

Purchaser: _____ Price: _____ Weight: _____



Y 1001

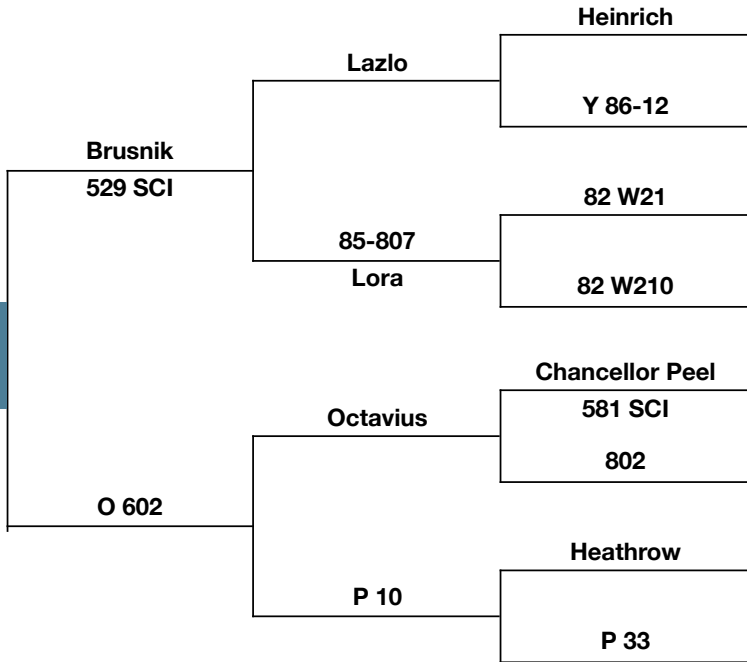

Y 1001 is another Brusnik son destined for higher honors. Brusnik speaks for himself with sons such as Brusnis, Huneric, Zidarn, Jabuka and Todd Crowleys Nixon, Brusniks highest scoring 3 yr old at 515IOA. On the Dam side is Octavius and G Dam P 10. P 10 produced Y 429 purchased by D Mackie for \$8000. He is showing great shape.

Purchaser: _____ Price: _____ Weight: _____

Y 1012

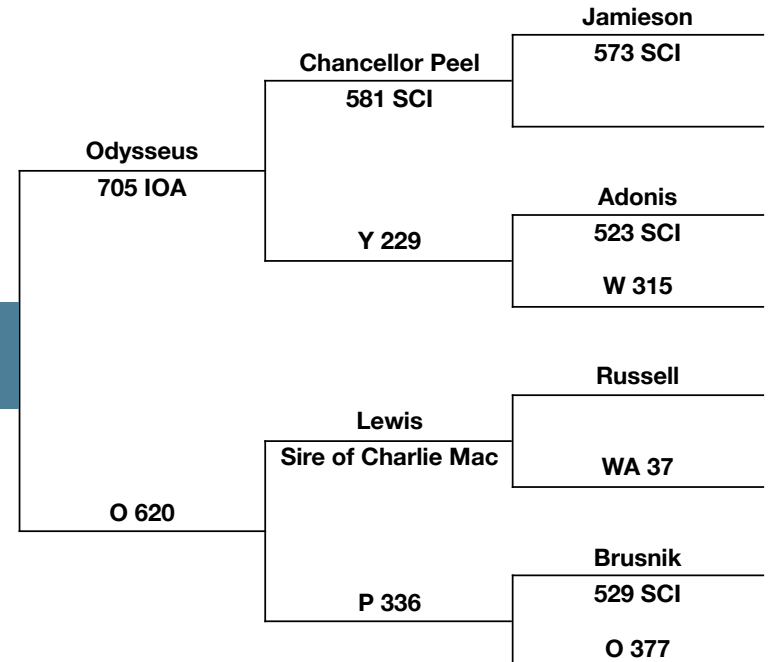

Y 1012 is the only Odysseus son on offer here today and is showing a very well balanced head with good long tynes. Dam O620 has Lewis (Charlie Macs sire) and Brusnik in her pedigree, which adds something special. A big stag with droppers off main beam.

Purchaser: _____ Price: _____ Weight: _____



Y 1008

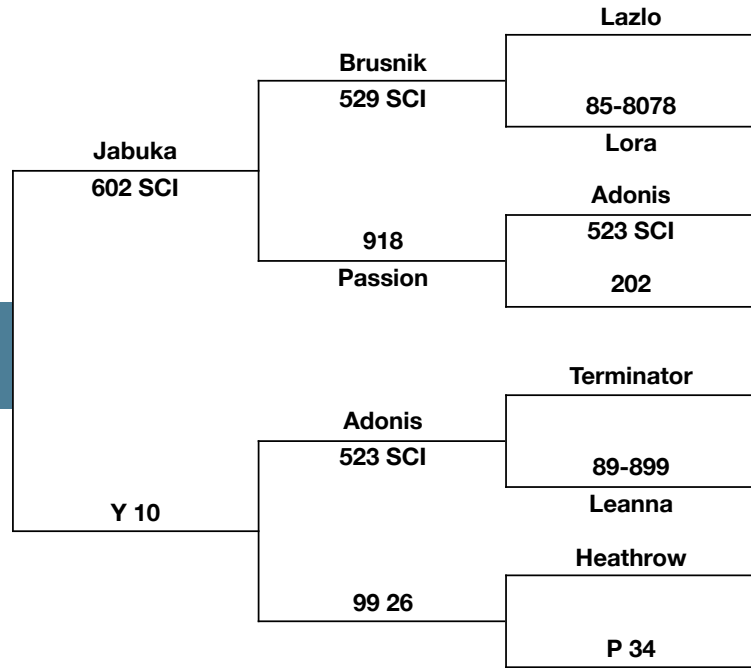

This is breeding at its best. The combination of Dam Y10 a Adonis/Heathrow daughter with the outstanding sire Jabuka (num two in the world taken with a bow) is a must for any herd. Y 1008 as started strong with good long tynes showing.

Purchaser: _____ Price: _____ Weight: _____

Y 1013

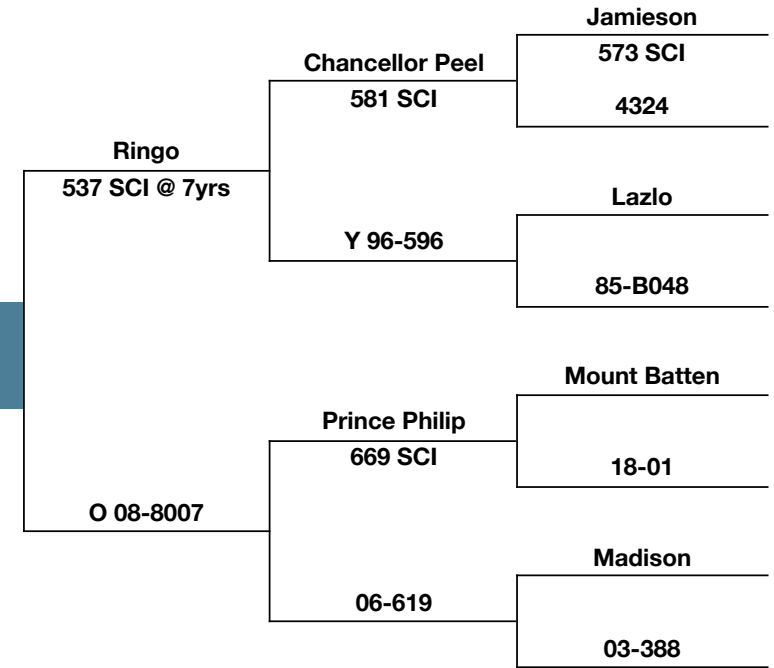

An exceptional stag not to be missed. Y 1013 is showing great tyne placement leading into a big heavy bulb with points to come. Ringo is a full brother to Salvador and he had a big wide multipoint set of antlers. 8007 is a full sister to the dam of lot 3 which sold for \$46000 at Foveran 2013. This stag is a must see.

Purchaser: _____ Price: _____ Weight: _____

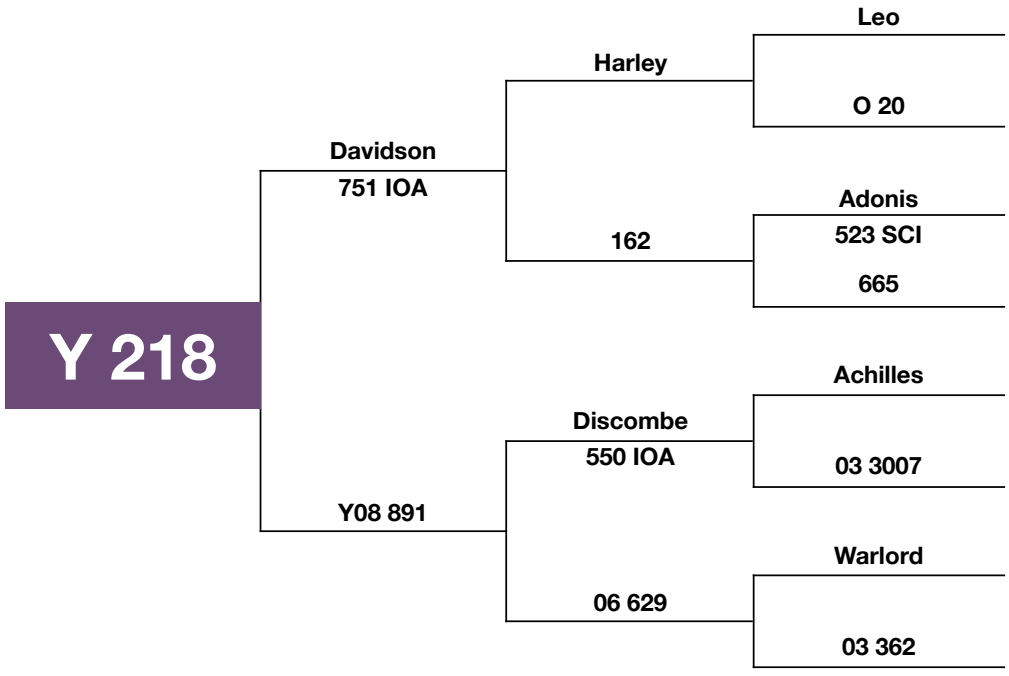
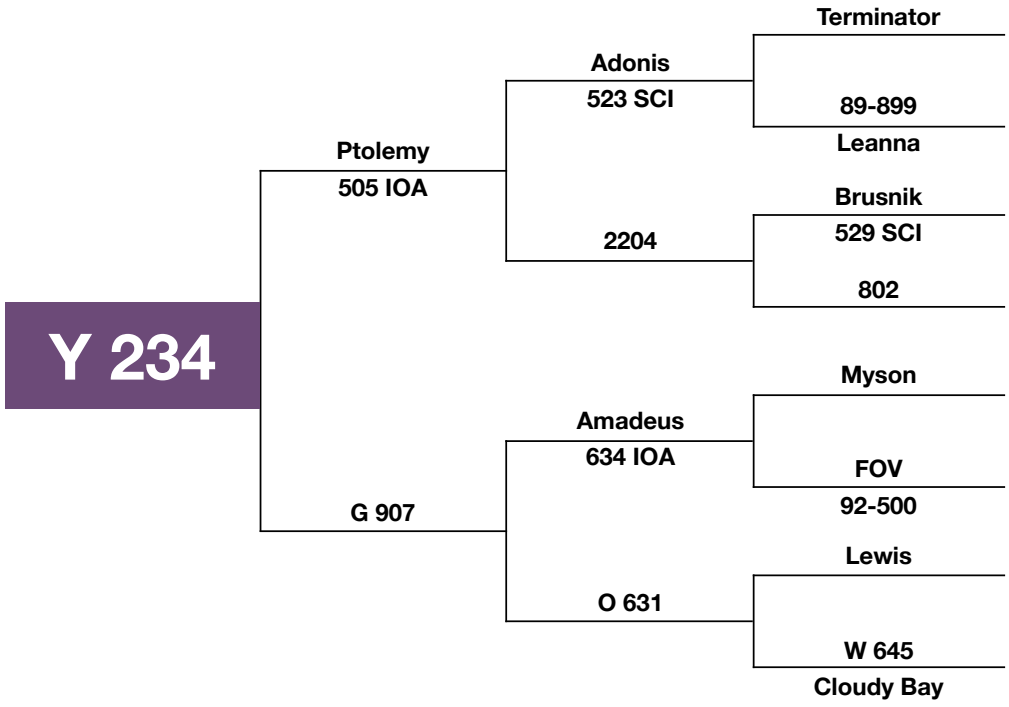

This is one of two Ptolemy daughters on offer today. She has width on both top and bottom with Ptolemy and Amadeus both of which have excessive spread. We look forward to this young hinds progression.

Davidsons heavy beam and multipoints scoring a phenomenal 751 IOA over a Discombe daughter is going to produce something special. Y 891 was purchased from Towerfarms and has only produced hind fawns thus far. With only a handful of Davidson daughters about, this one is not to be ignored.

Purchaser: _____ Price: _____ Weight: _____

Purchaser: _____ Price: _____ Weight: _____

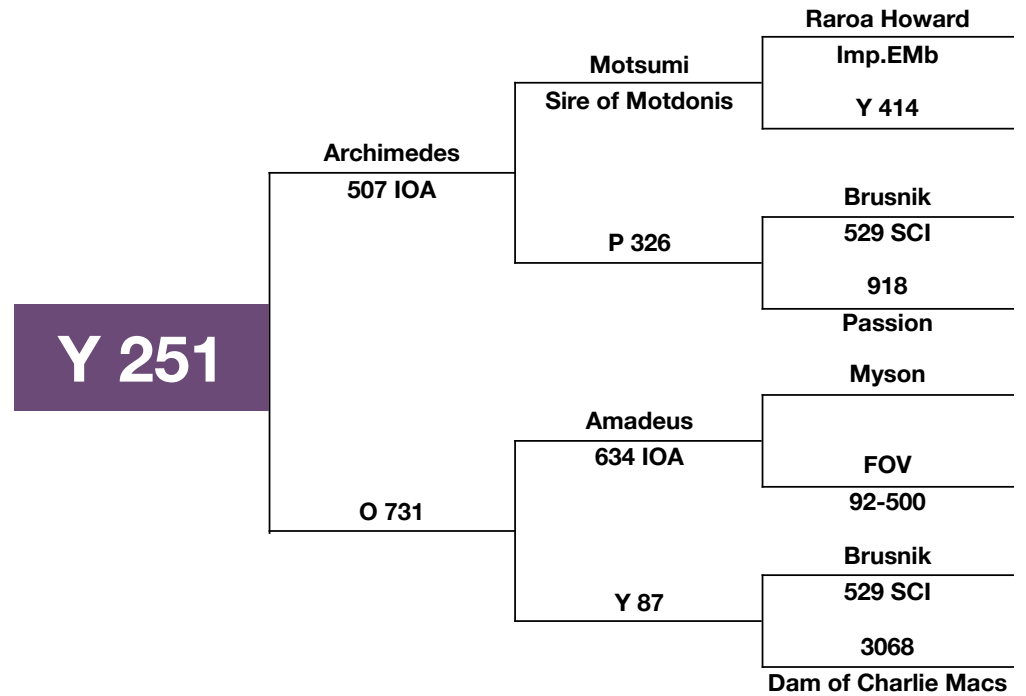
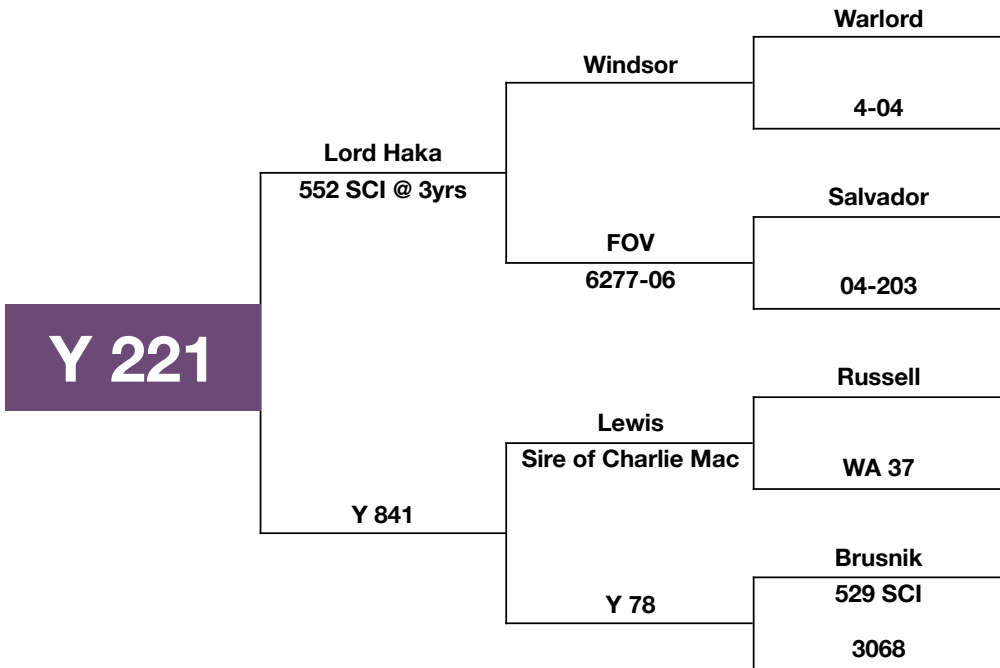

This is magnificent breeding with Lord Haka (201kg 13.5kg hard antler 502 IOA @ 2yrs) over a Lewis x Brusnik x 3068 hind. Y 221 has everything you need and is a top young hind. The results from this hind will be very special and we look forward to her progress. Note that Y 221s G Dam is a full sister to lot 5s G Dam.

Here is another chance to secure fantastic genetics in this young hind. Dam 731 is a full sister to Lot 5s Dam O 761, and similar breeding to Lot 13. The proof in this breeding is already there, we regard this particular breeding very highly.

Purchaser: _____ Price: _____ Weight: _____

Purchaser: _____ Price: _____ Weight: _____

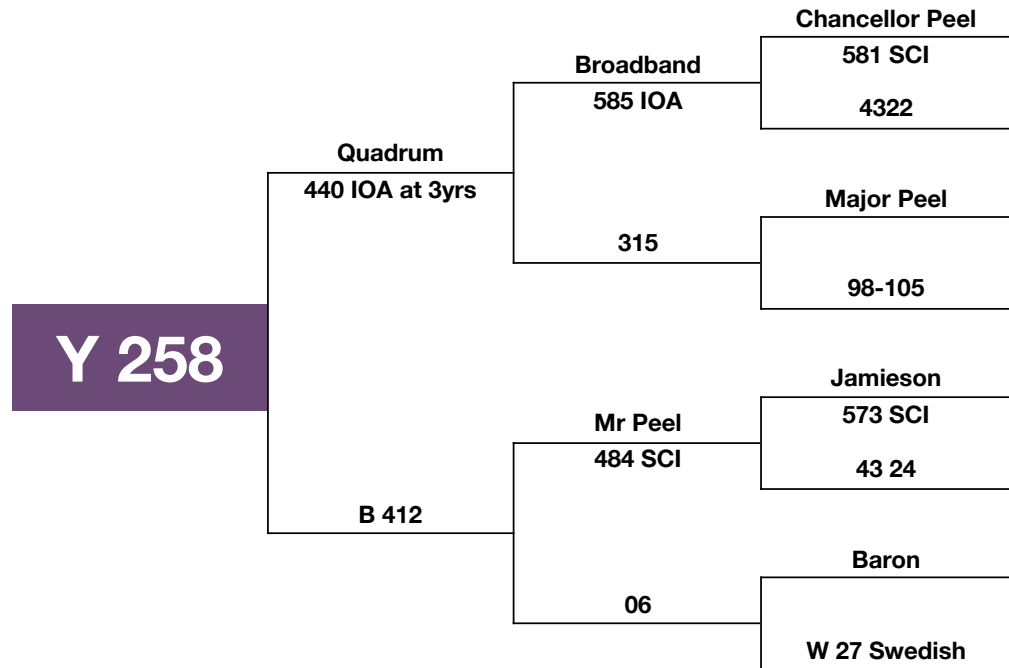
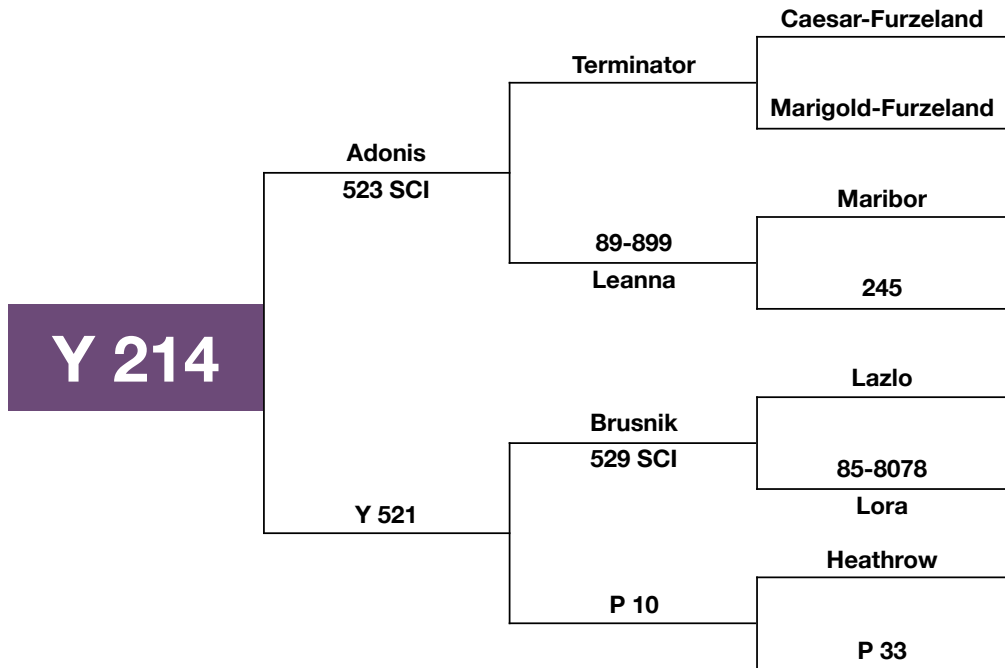

Young Adonis hinds are very sort after and with having Brusnik and Heathrow in the mix makes this hind even more exciting. Note that P 10 was Dam of Y 429 purchased by Dave Mackie for \$8000 and was dam of Dartanion at Willowcreek, she also features in lot 7 this year.

The only Quadrum daughter on offer today. B412s Sire Mr Peel is Chancellor Peels full brother, and crossed with a Baron daughter gives you great antler genetics throughout this pedigree.

Purchaser: _____ Price: _____ Weight: _____

Purchaser: _____ Price: _____ Weight: _____

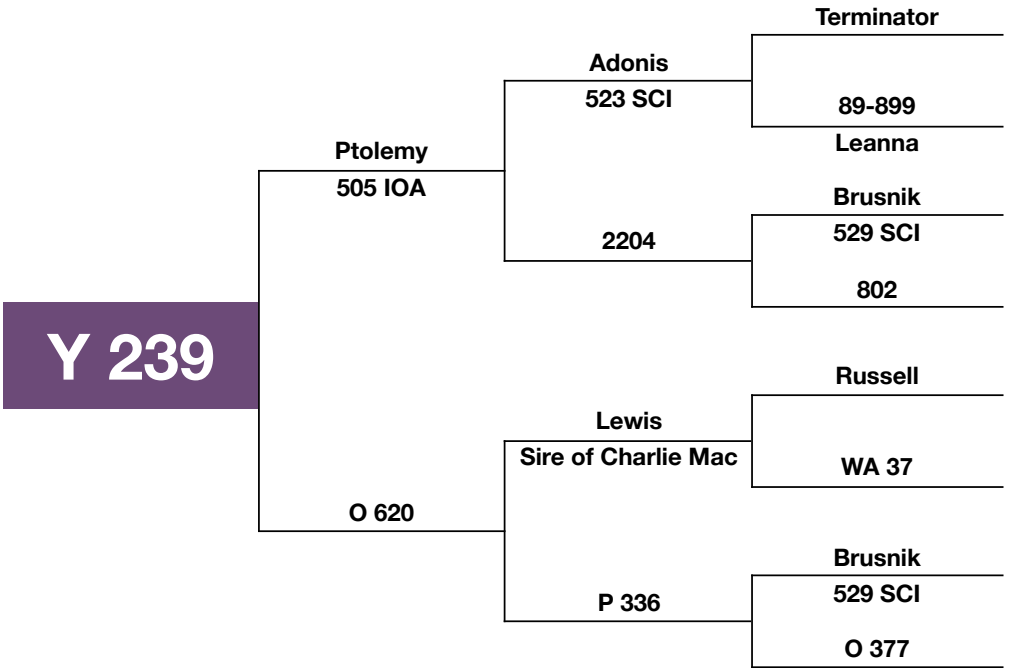
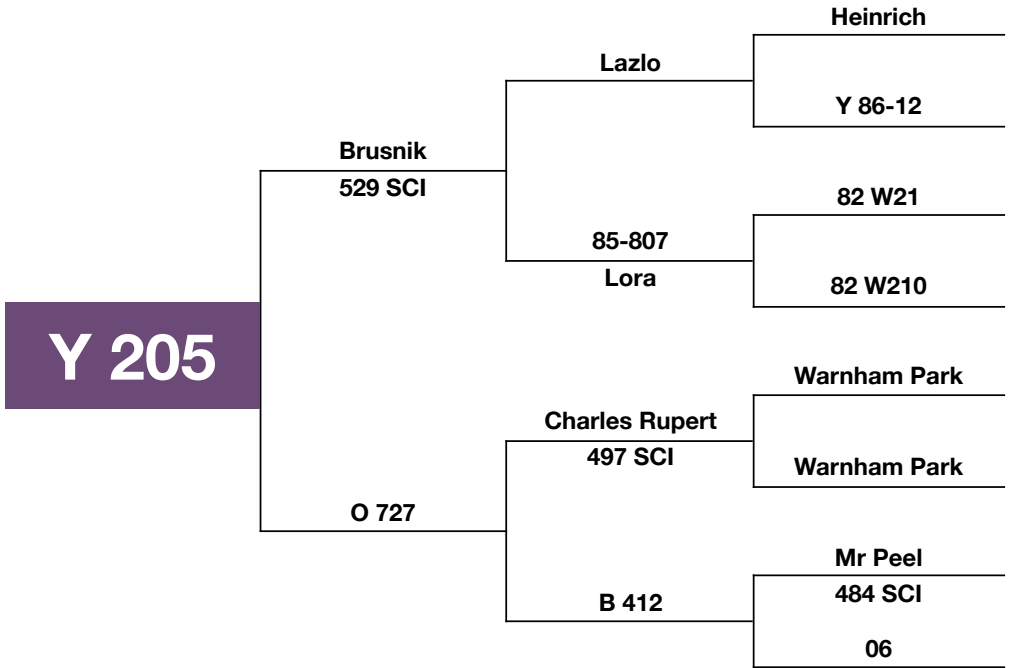

Both Brusnik and Charles Rupert are very respected Sires. Brusnik has sired some of the industrys greatest stags such as Zidarn, Jabuka, Brusnis, Huneric and Nixon to name a few. A good chance to secure a nice Brusnik daughter.

The last Ptolemy daughter on offer, this young hind has both width and points in her pedigree. Dam 0620 has had 1 stag and 3 hind fawns but G Dam P336 has had three stags which have made our trophy mob, one of which scored 445 at 5 years. Note Dam 0620 is also the Dam of Lot 8.

Purchaser: _____ Price: _____ Weight: _____

Purchaser: _____ Price: _____ Weight: _____

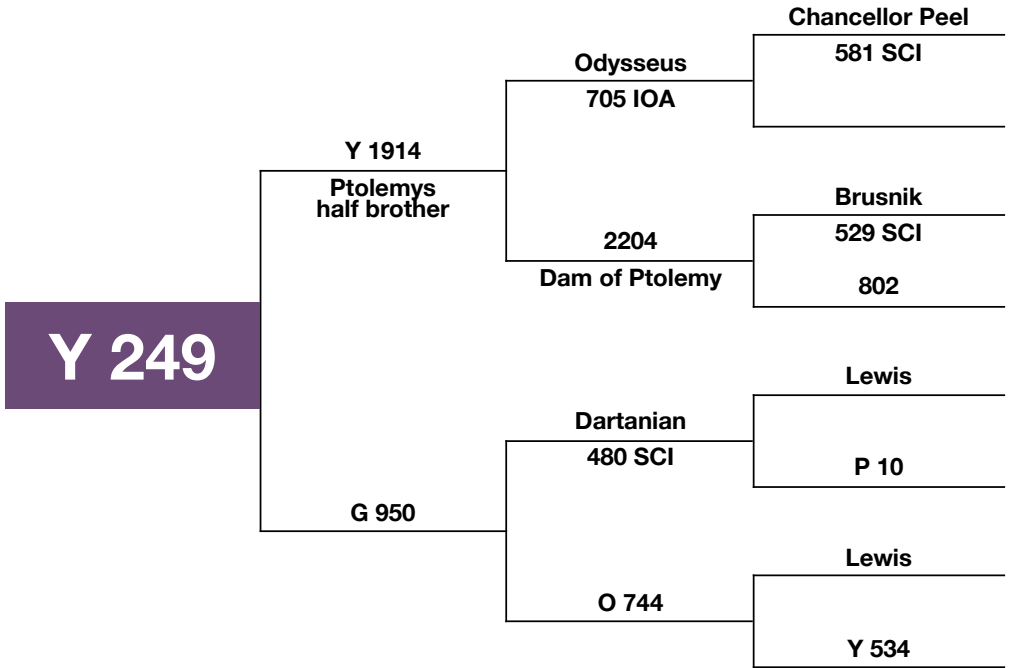
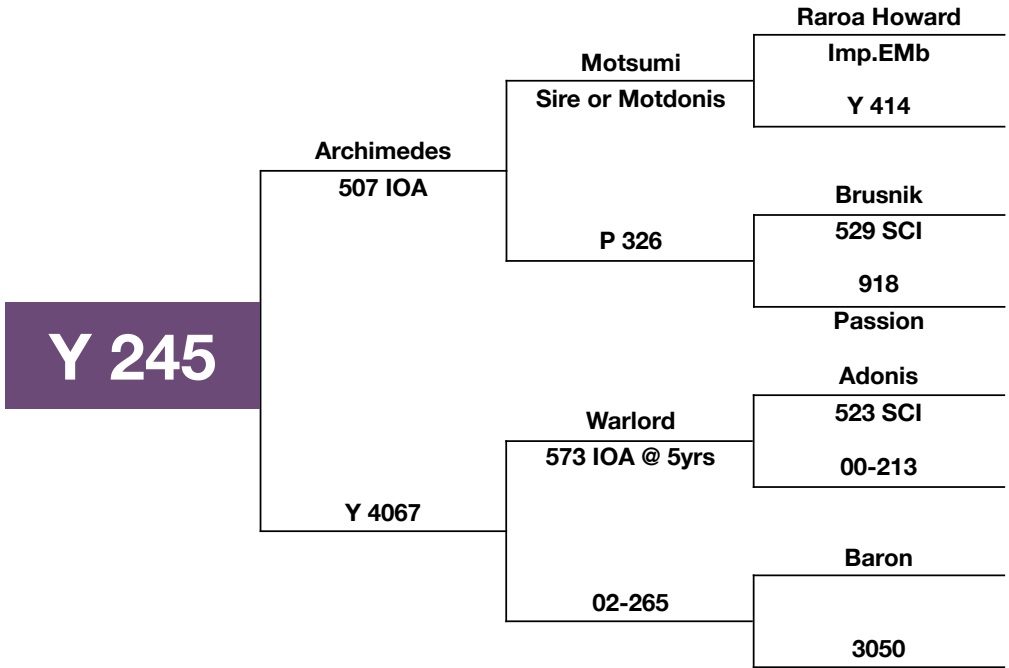

Archmedes sire Motsumi, is also sire of Motdonis 735IOA. Warlord is G sire of the incredible Lord Haka which features in this pedigree. Dam Y 4067 has had three hinds and one stag, which has cut nice clean velvet at 4.7kg and will enter the trophy list next year.

A quality pedigree with Y1914, half brother to Ptolemy crossed with a double Lewis hind. Note Lewis was Charlie Macs sire who was a former SCI and CIC World Champion.

Purchaser: _____ Price: _____ Weight: _____

Purchaser: _____ Price: _____ Weight: _____

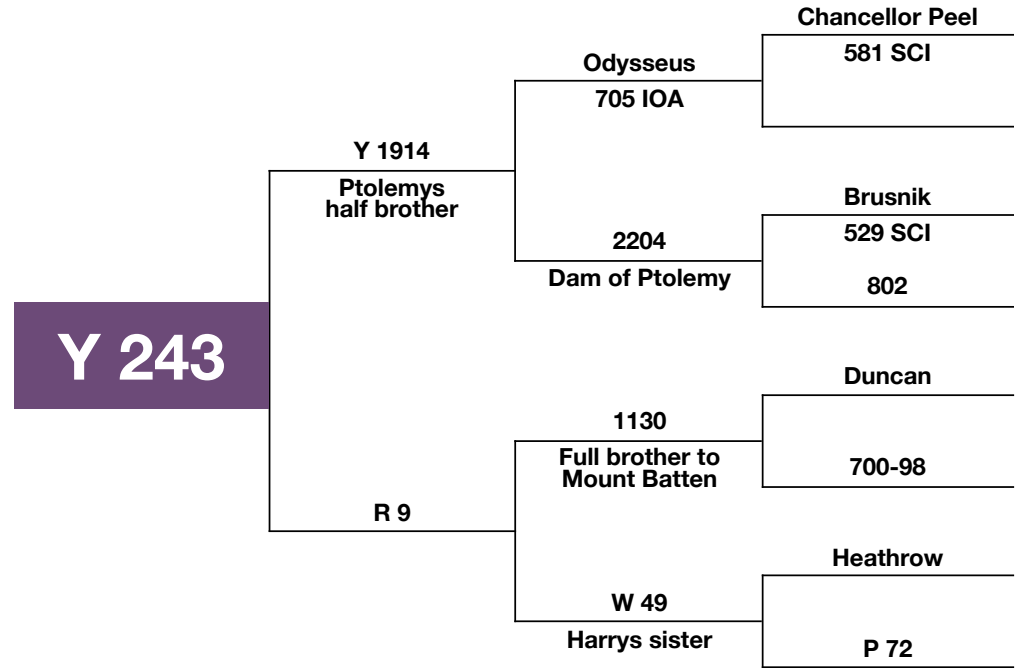
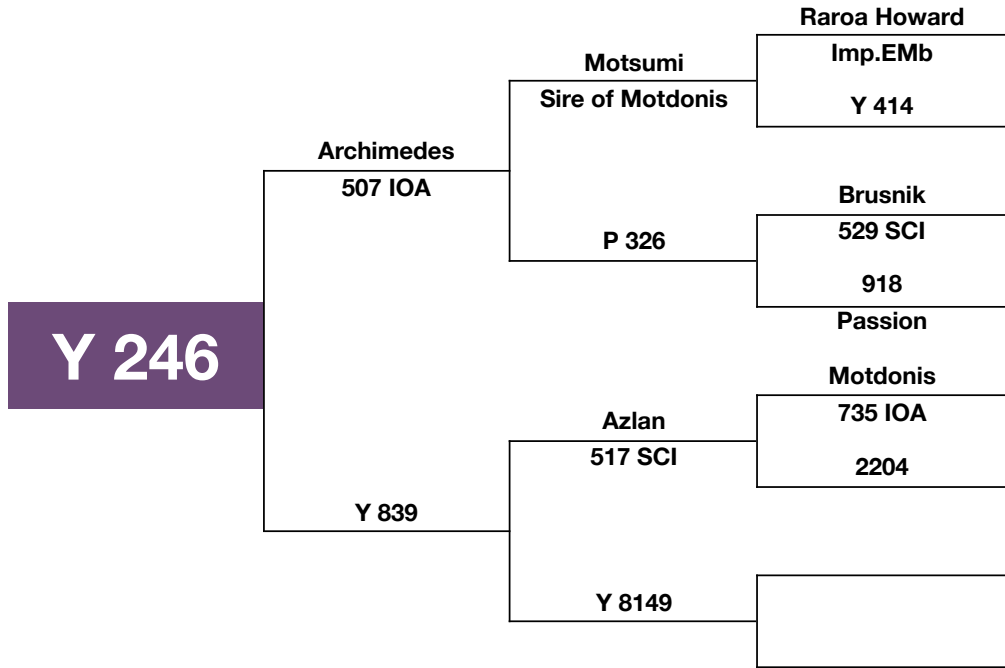

A young hind not to be overlooked and can offer big things. Achimedes has son's starting to perform for us, and coupled with yet another son of 2204 (Azlan), will carry on and enhance your genetic gains.

Y1914 is Ptolemy's half brother and although young, is showing a nice long, clean, classic style set of antlers which the trophy hunters are looking for. 1130 is Mount Battens full brother, and W 49 is a full sister to Donald Griegs Harrys Dam.

Purchaser: _____ Price: _____ Weight: _____

Purchaser: _____ Price: _____ Weight: _____



Y 225

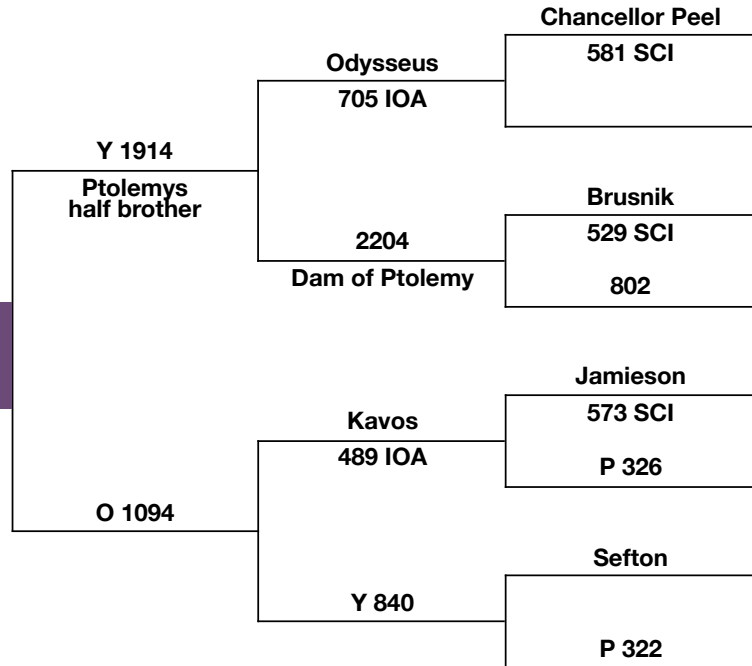

Y225 was bred with long clean open antler in mind. Y 1914 is Ptolemys half brother and has long clean correct antler. Dam Y 840 has one stag and two hinds on farm and with Kavos adds points.

Purchaser: _____ Price: _____ Weight: _____

Y 240

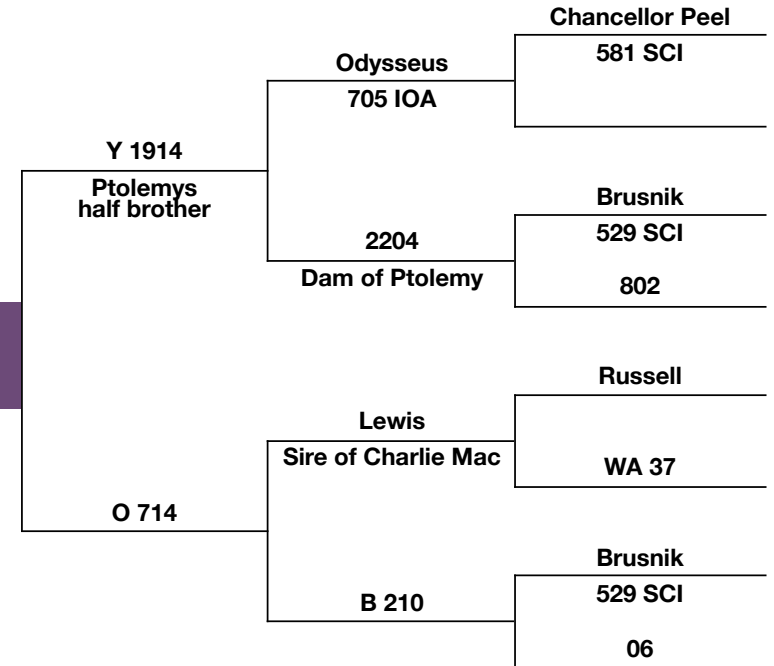

Y240's GDam B210 has two hinds and two stags on the Farm. Dam sire Lewis was sire of Charlie Mac and was a world champion stag. Y240 is a hind that will compliment any breed plan.

Purchaser: _____ Price: _____ Weight: _____



Buyer Instruction Slip

(No verbal instructions accepted)

Name: _____

Address: _____

Lots Purchased: _____

Insurance: **Yes** **No** (please circle)

Delivery Instructions _____

Signature of Buyer or Agent _____



XCELL
BREEDING SERVICES LTD

Post Mortem Sperm Recovery

If your stag is discovered dead or scheduled to be shot for trophy, all is not lost. Xcell is successfully utilizing a technique where we recover and freeze live semen from the dead animal's testicles.

Contact Xcell immediately then follow the procedures below to assist in achieving the best results.

- Remove testicles from the base of the underbelly complete with sac as soon as found or shot
- Wrap testicles in a towel then place in a plastic bag and seal
- Place 2 inches of ice or cool pack in the bottom of a small chilly bin, cover this with 1 inch of newspaper
- Place testicles on top of newspaper and pack more newspaper around to hold firm
- Deliver to Xcell Breeding Centre same day or airfreight to Christchurch "Airport Only" with Xcell as consignee

Breeding Centre 03 327 9555
Mobile ph 021 453 387 or 021 453 384

www.xcell.co.nz



BE PREPARED – CLIP AND KEEP BY THE PHONE



Willowcreek Deer

Harry & Carol Waghorn

Lower Sefton Road, RD 7, Rangiora, New Zealand

Phone: +64 3 312 9856 Fax: +64 3 312 9850

Email: willowcreekdeer@clear.net.nz